

Products group:
CAMPING PRODUCTS

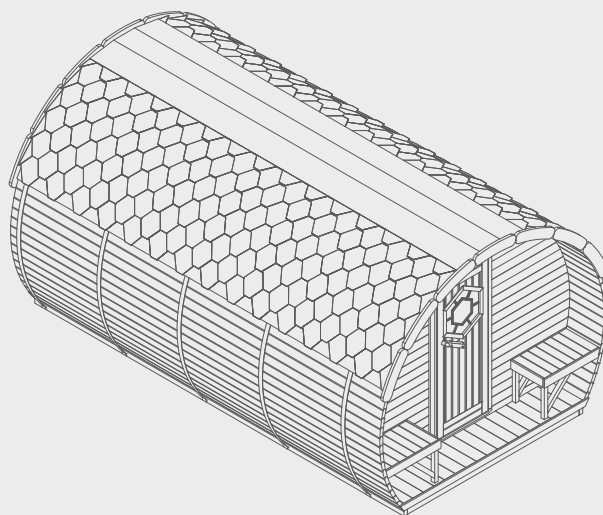

*For your garden
beauty growth!*

PRODUCT SHEET
Sleeping barrel
„Ice-Viking“

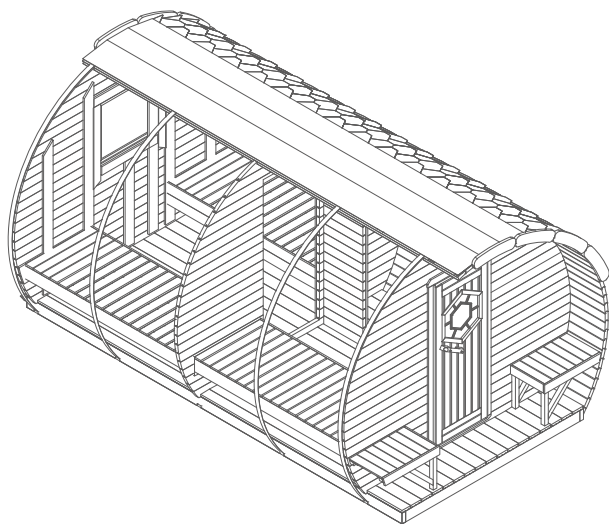

Product Specifications

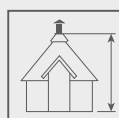
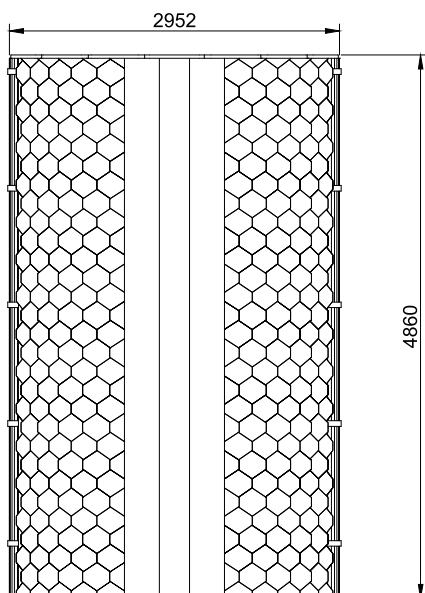
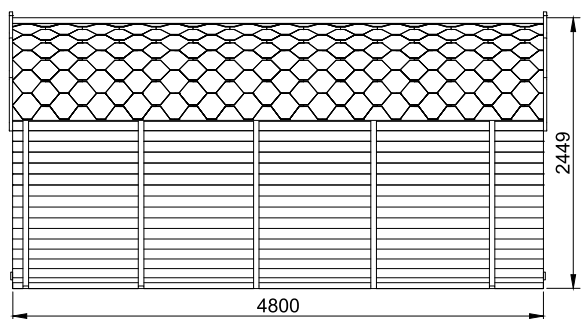
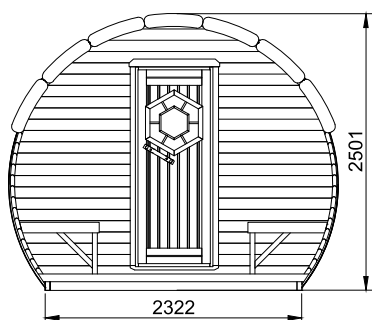

2500 mm

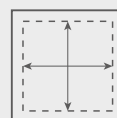

9.5 m²

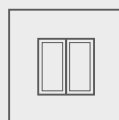

1



Spruce

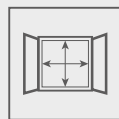

830 x
756 mm

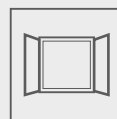

1



4-10

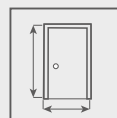

700 x
1725 mm

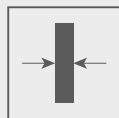

38 mm



1880 kg

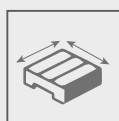

Not assembled
4.8 x 1.2 x 1.5 m

Standard Set

- Barrel made from spruce;
- Roof covered with bitumen shingles of your selected color;
- Stainless steel tightening bands;
- One opening window in the back wall;
- Doors with a lock and a window;
- Two rooms inside: a sleeping room and a sitting room;
- Available to make sleeping space at sitting room;
- Sleeping room with a sleeping space: 2 x 2,3 m;
- Small benches at the entrance.

This sleeping barrel has two rooms which you can turn into any space you need. We have a few examples how you can model interior space by your needs:

- Sleeping space
- Shower/toilet/storage space
- Dining space with table and two seats

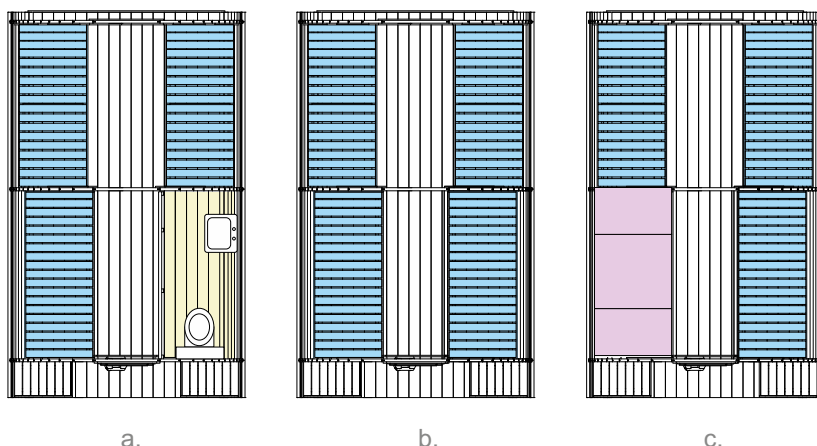

TYPE OF WOOD

SPRUCE

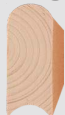

We mainly use Nordic spruce, which comes from Scandinavia. The light, golden-white softwood radiates a friendly warmth. Every single board used for our Sauna Barrel has its own individual character and history, and this makes our Sauna Barrel a real natural and unique product.

ROOF SHINGLES

BITUMEN SHINGLES

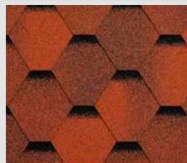
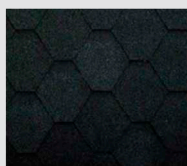

6 layer bitumen shingles are made from a durable and highly resistant fiber glass base coated with the polymer-reinforced bitumen mix which includes a high quality bitumen and an aggregate. The top layer of the shingles is covered with mineral granules ensuring the protection from UV as well as from other weather conditions. The granules are painted using a thermal method, which means that a pigment is burned-in into the surface of granules and this guarantees a long durability of the color. The bottom of the shingles is an adhesive polymer-reinforced bitumen layer protected with an easily removable silicon membrane. Due to the sun heat the overlapped tiles on the top stick to each other thus forming a double hydro-insulating layer which guarantees an excellent leak resistance of the roof. A color of the roof shingles can be chosen from black, green or red. A warranty term for the shingles is 15 years!

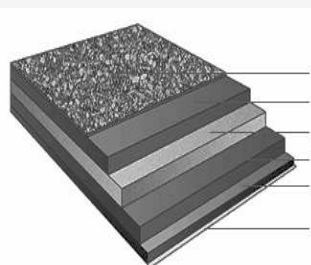

1. Top layer - mineral surfacing
2. Bitumen mass
3. Base - fibre glass
2. Bitumen mass
4. Bottom layer - adhesive polymer-reinforced bitumen
5. Protective layer - easily removed silicon membrane

WINDOWS AND DOORS

Window's size is 830 x 755 mm, door's size is 700 x 1725 mm. Double glass units and tempered glass are used; they windows ensure lower heat transfer to the outside, a lot of light coming inside, and long usage time.

TRANSPORTATION

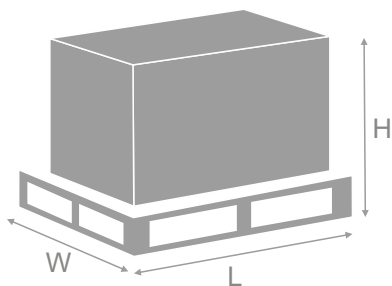

Pallet size:
1200 x 1600 x 4850

The Ice-Viking barrel is delivered to a customer not assembled (packed on a pallet (KIT)) but fully complete. Assembly instruction of this product you can download and print from www.vikingindustri.com Dealer site(downloads) or email your Viking Industrier sales manager.

FOUNDATION

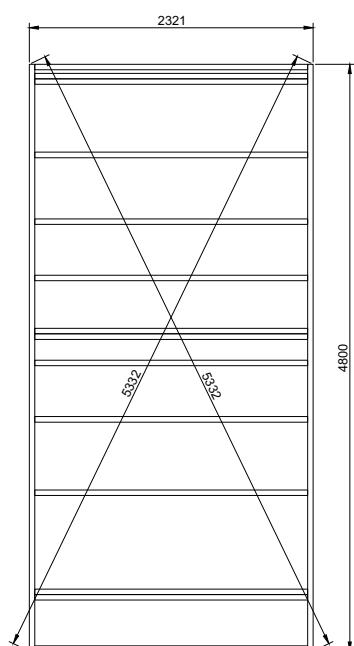

It is very important to have a proper foundation for your barrel. Therefore we recommend making the foundation according to the sketches here.

First of all, foundation must be prepared according to the landscape and ground conditions. Consult a qualified builder or an engineer to prepare a proper foundation, which fits your location. Make sure to complete the site preparation and the foundation before unpacking and assembling the barrel.

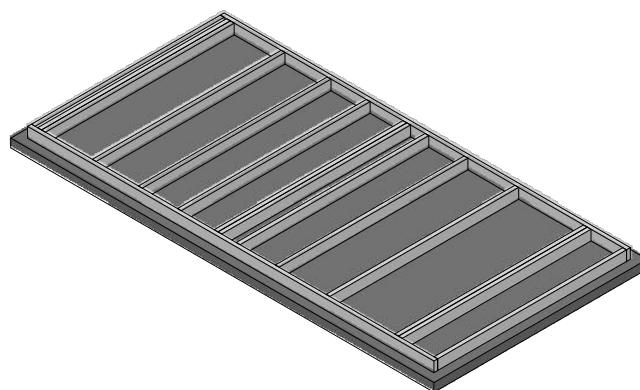



































MAINTENANCE

As wood is a natural material, it can change through time. Cracks of various sizes, changes of the color as well as a structure of the wood are not the errors, but a feature of a wood. Natural wood (not impregnated) becomes grayish after having been left untouched for a while. Later it can turn blue and get covered with the mold. Therefore, you should immediately impregnate the wood to protect the products.

We strongly recommend that you impregnate the door and windows with a wood impregnation agent both the inside and outside of them, because the doors and windows can become twisted otherwise. In general, we recommend consulting a specialist regarding the paints suitable for an unprocessed softwood and follow the manufacturers' of paints instructions. Properly painting the product will extend its lifetime. Besides that, we suggest you thoroughly inspecting the product every six months and checking if it needs re-painting or else. It's NOT advisable to paint the walls before assembling it – this is best done when the product has been already assembled and when the weather is fine. However, if you wish to paint some parts in different colors, this should be done before the product is assembled.

Symbols

	Height of roof ridge		Total number of windows		Height of tub		Number of persons
	Height of wall		Number of opening windows		Total height of tub		Tub shape
	Area		Size of windows		Water capacity of tub		Diameter of tub
	Diagonal		Size of doors		With external wood burning heater		Height of pod
	Wall thickness		Weight		With internal wood burning heater		Number of benches
	Wood spruce		Size of pallet (LxWxH)		Heater with external firewood feeding		Doghouse entrance hole size
	Thermo wood		Length of barrel		Inside feeding heater		Wood burning heater
	Shape		Diameter of sauna barrel		Electric heater		
	Measurements of extension		Stones for heater		Voltage		