









































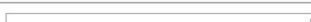







<u>PRODUCT NAME</u>	<u>DREUX (5x5)</u>
<u>REFERENCE NUMBER</u>	

No.	Dimensions cm W x H x L	Quantity	Image	Profile	Part name/ Used for:
2.	5x7x484	12			<b>Bearers</b>
3.	4,3x65x500	2			<b>Wall A B</b>
4.	4,3x13x500	34			<b>Wall B C D</b>
5.	4,3x13x322	7			<b>Wall A</b>
5a.	4,3x13x92	23			<b>Wall A</b>
5b.	4,3x13x91	8			<b>Wall A</b>
6.	4,3x13x98	7			<b>Wall C</b>
6a.	4,3x13x263	8			<b>Wall C</b>
7.	4,3x13x124	1			<b>Wall C</b>
7a.	4,3x13x526	1			<b>Wall D</b>
7b.	4,3x13x553	2			<b>Wall CD</b>
7c.	4,3x13x590	2			<b>Wall CD</b>
8.	4,3x78x500	2			<b>Roof frame triangle</b>
9.	5,7x13x590	1			<b>Rafter</b>
9a.	5,7x13x590	4			<b>Rafter</b>
10.		34,22 m <sup>2</sup>			<b>Roof boards</b>
11.	2x10,5x300	4			<b>Wind board</b>
11a.	2x10,5x302,5	4			<b>Wind board</b>
11b.	1,6x8x302,5	4			<b>Wind board supporter</b>
12.	2x10,5x590	2			<b>Roof plank</b>
13.		22,8 m <sup>2</sup>			<b>Floor boards</b>
14.	2,5x3,5x475,4	4			<b>Floor trim</b>
15.	20x14x30	2			<b>Decorative diamond</b>
16.		1			<b>Door</b>
17.		2			<b>Window</b>

Screws			Nails		
	3.5x5	For windows and doors		2.5x6	For boards
	3.5x3	For roof decorative parts			

**IMPORTANT (Read carefully before starting)!**

- The following instructions include both pictures (indicating every part by the digits – see part list above) and illustrations. Please keep in mind that the illustrations are just a general guide to assembling all our products (For example: The illustration on how to assemble a roof applies to all our roofs). However specific models will vary in the quantity of materials needed. By closely consulting the part-list, you will know how many parts you need for each stage of the assembly, while the illustrations will show you how put them together.

- If some extra boards are left over after assembling your product, do not worry. We sometimes include extra boards to ensure that the delivery package is perfectly compact and solid.

1. **General instructions**

**Read carefully before starting.** First of all, we want to thank you for buying one of our products. Please read these instructions carefully before unpacking the parts.

**2. Storing your product prior to assembly.**

Your unpacked product must be stored in a dry, ventilated place, where it is protected from the weather (the package is not waterproof) and direct sunlight. The package and parts should be laid flat on the ground in order to avoid any damage to them. We strongly recommend assembling the product as soon as possible after it is delivered, because any complaints regarding missing or damaged parts can only be made up to 10 days after the date of delivery.

**3. Safety.**

The wooden parts may cause splinters, so please handle them carefully and wear protective gloves. Make sure there are no protruding nails, screws or staples in the assembled pieces. Always follow the instructions carefully and keep to the order of steps.

#### **4.Assembly.**

During the installation process constantly check that everything is level and parallel. For all parts that need to be assembled using screws, it is advisable to pre-drill holes to avoid the risk of splitting the wood during screwing.

**4.1. Familiarize yourself with the parts.** All parts are numbered, so start by checking that all parts are present by matching them off against your instruction manual. We recommend you sort the parts into separate piles. You will need a rubber hammer, electric screw-driver and anchor screws.

**4.2. Foundation.** Before starting the installation, make sure that the building surface is perfectly flat and level. Lay the foundation elements (PVC blocks, concrete slabs, etc.) For floorless models, the foundation should be at least the same size or larger (recommended) than the external dimension of the structure.



**4.3. Bearers.** The bearers must be placed according to the picture (basic sample) below with gaps of 50cm between each other. Screw the bearers into the foundation with anchor screws.

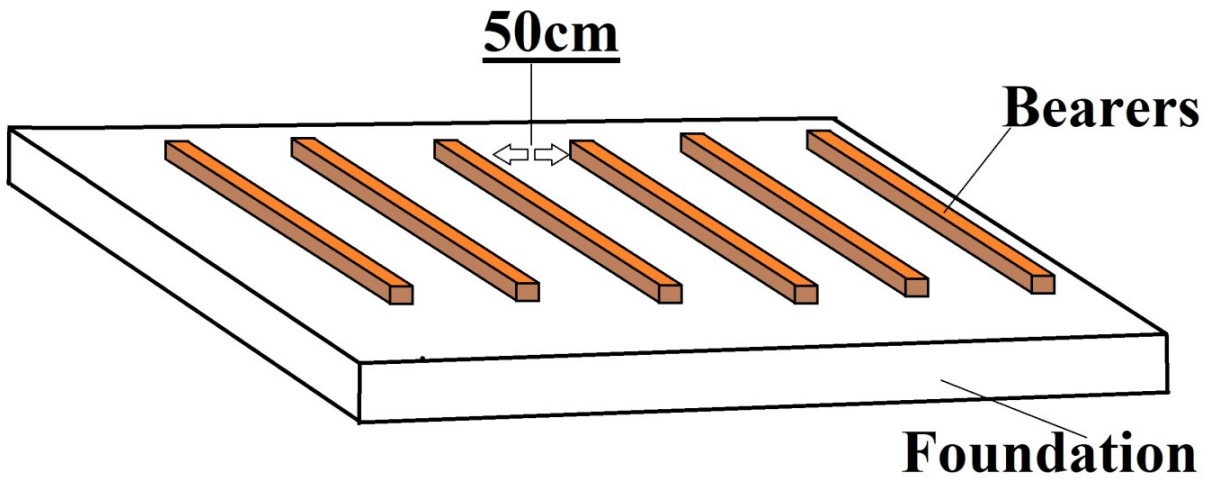

The actual bearer plan:

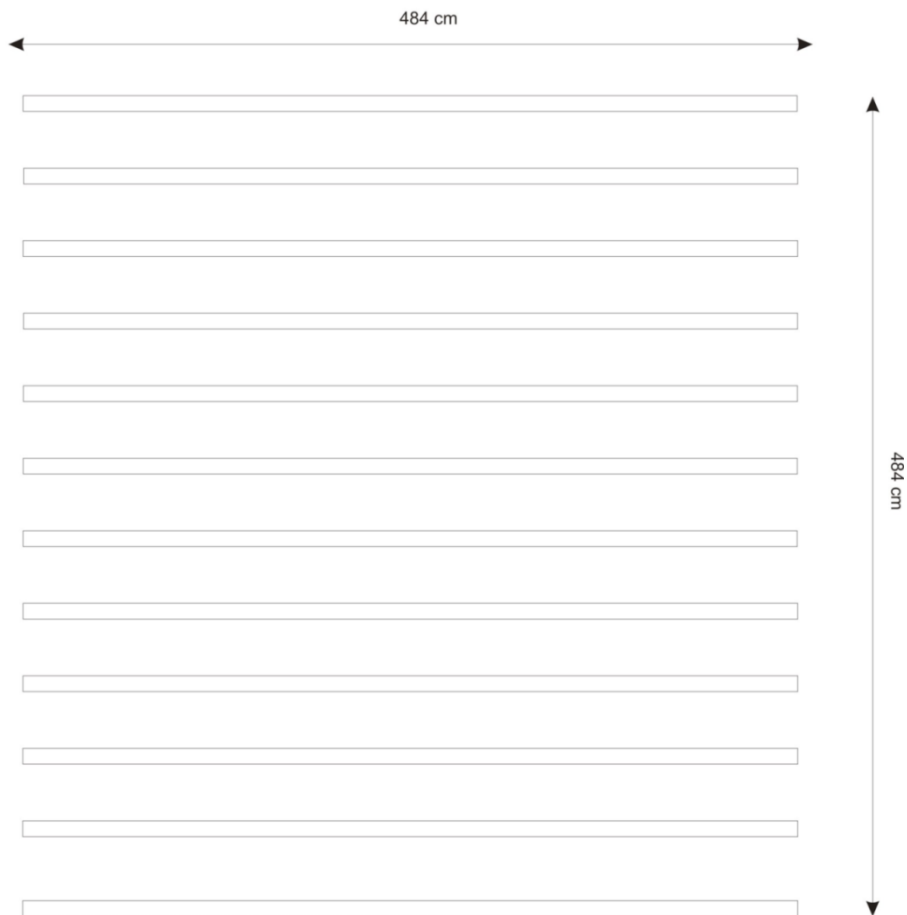

**4.4. Assembling the walls:** place the wall-boards on the bearers as shown in a sample below:

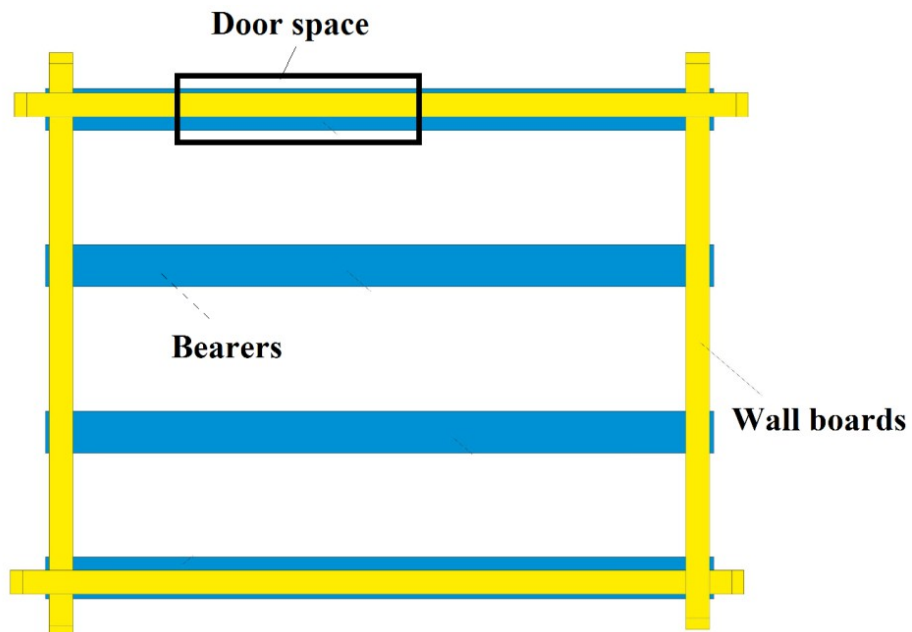

The wall-boards must be placed so that the ends interlock. Now screw the first row of wall-boards into the bearers. All the following rows of placed wall-boards should interlock not only at the ends, but along their length as well. Please screw each new row of wall-boards into the former row to ensure a solid structure.

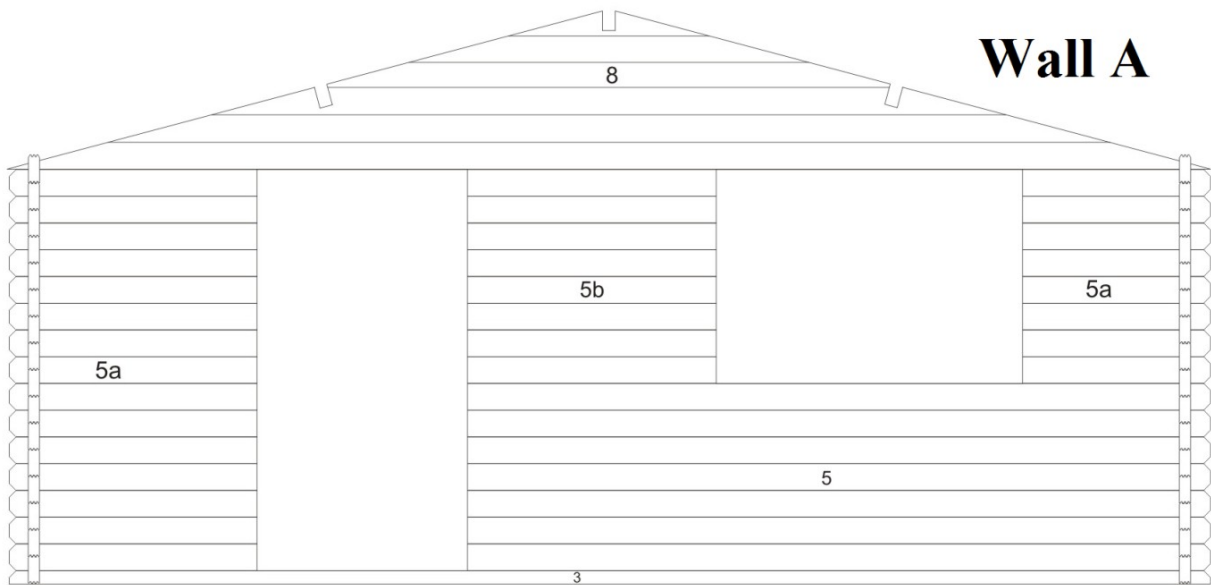

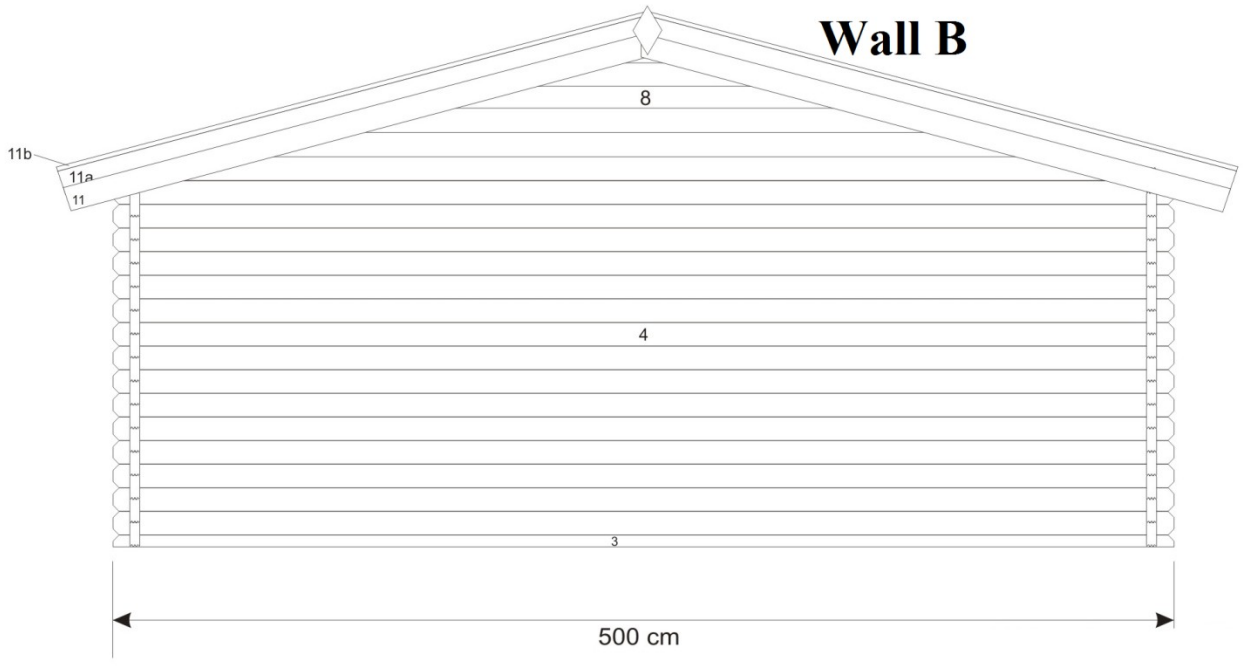
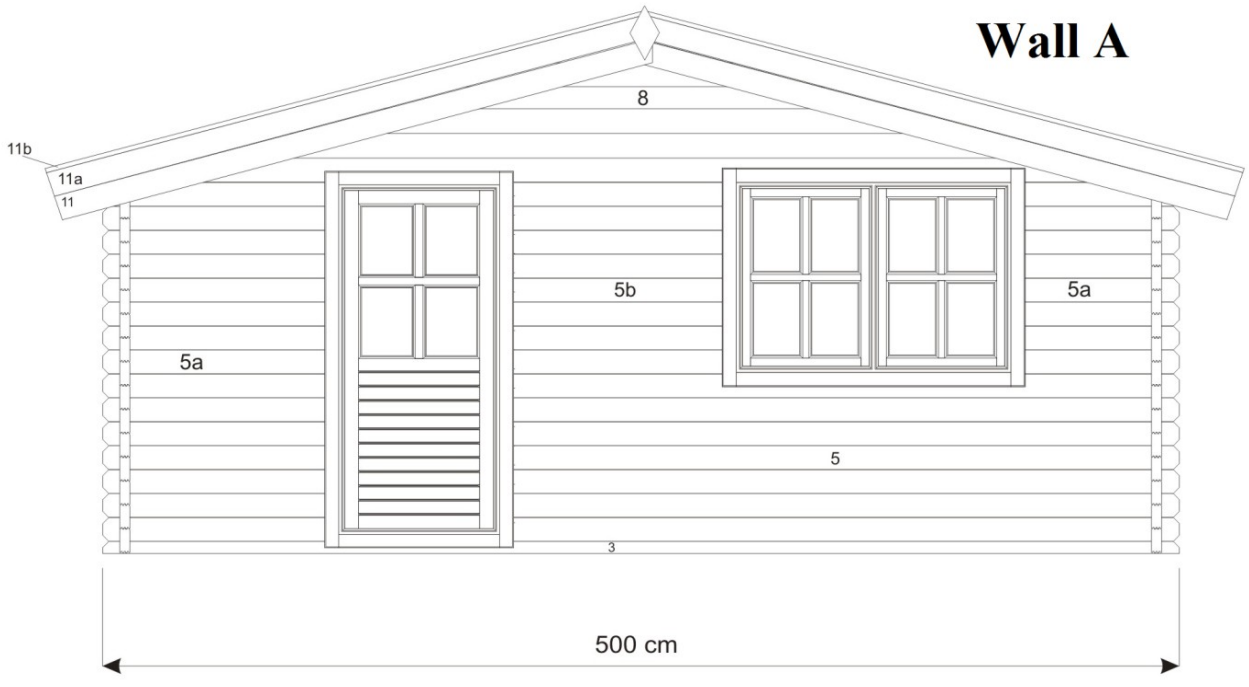

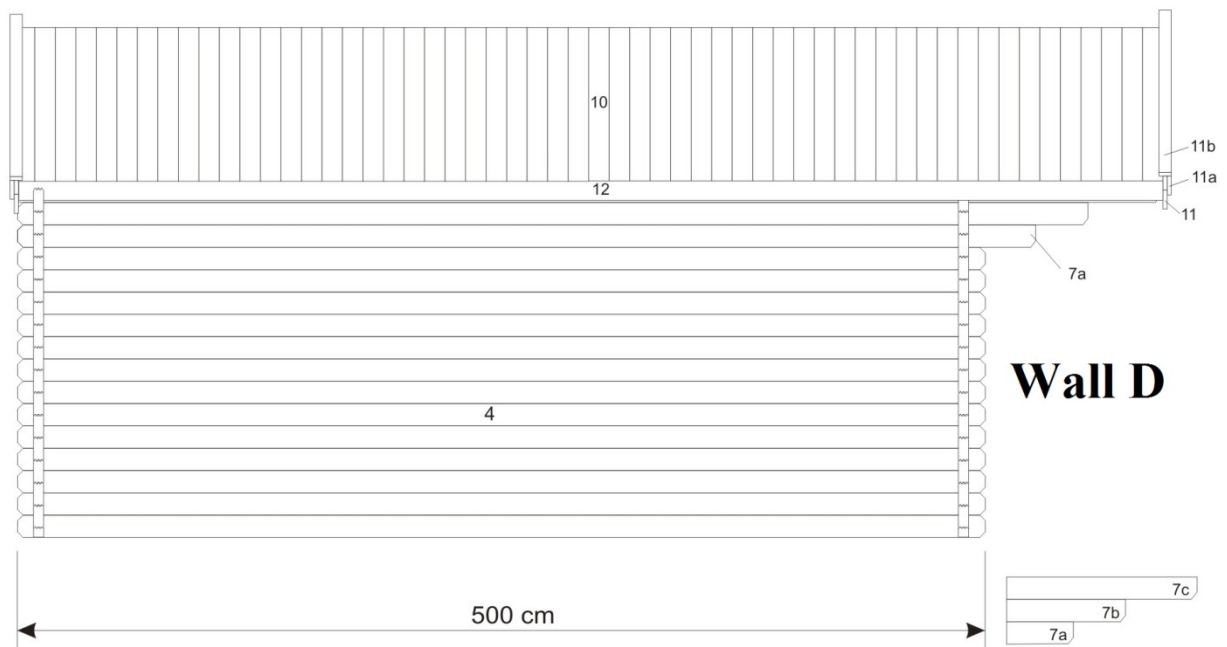
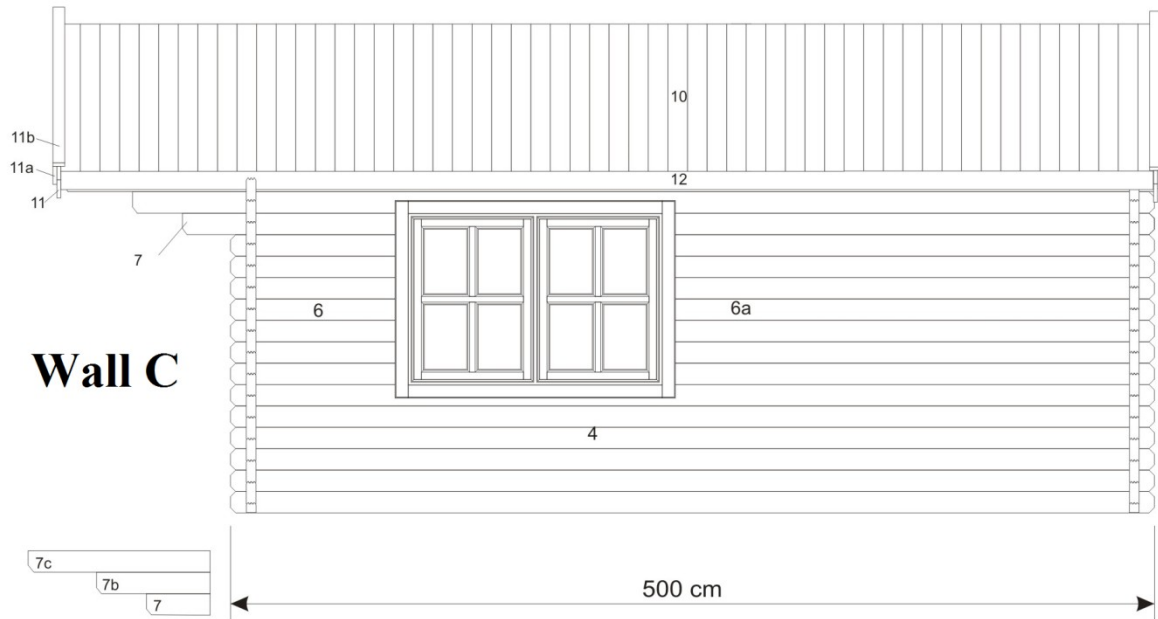

**4.5. Roof frame triangles:** After the walls are assembled, mount the roof frame triangles. These should be mounted as whole structures.



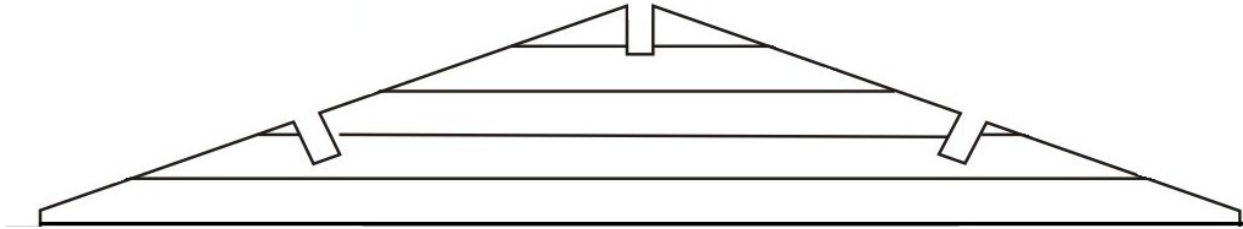

**4.6. Rafters:** The rafters must be mounted horizontally and inserted in the mounting-spaces found on the roof frame triangles.

## Rafters

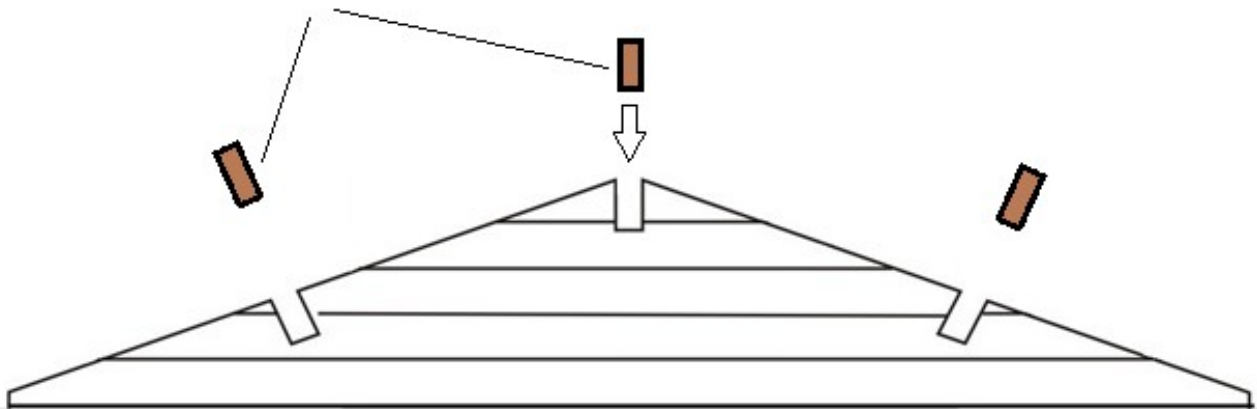

**4.7. Roof-boards:** The next step is to attach the roof-boards vertically and screw them into the rafters. Make sure the ends of the roof-boards are perfectly parallel to each other. Then fix the roof plank boarder under the roof-boards as show below. The roof-plank must be screwed to the roof plank boarder.

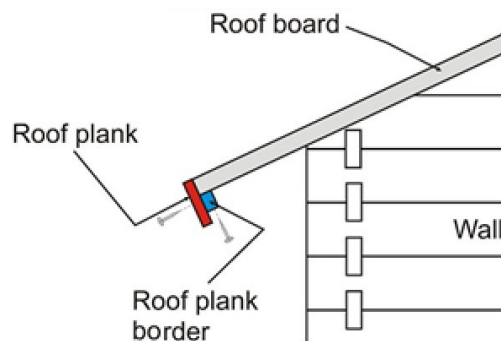

**4.8. Wind-boards:** Place the wind-boards on top of each other to make a 90 degree angle. Now attach these ones on a roof frame triangle and fix with by screwing in.

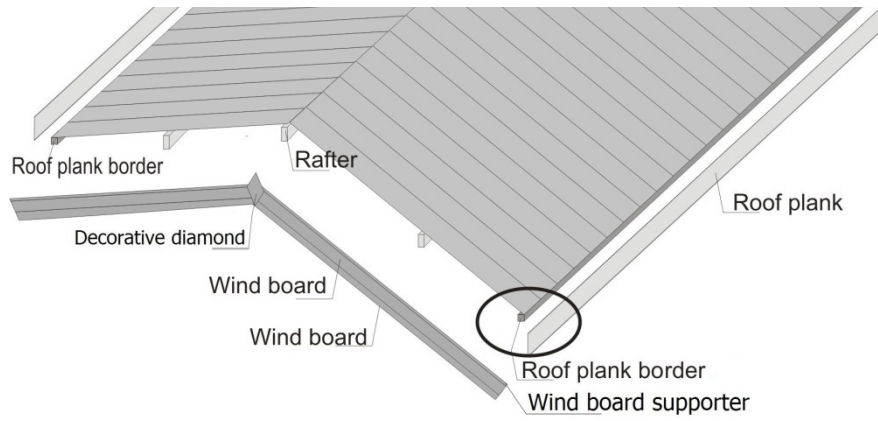

**4.9. Door:** Assemble the door frame fixing it with screws:

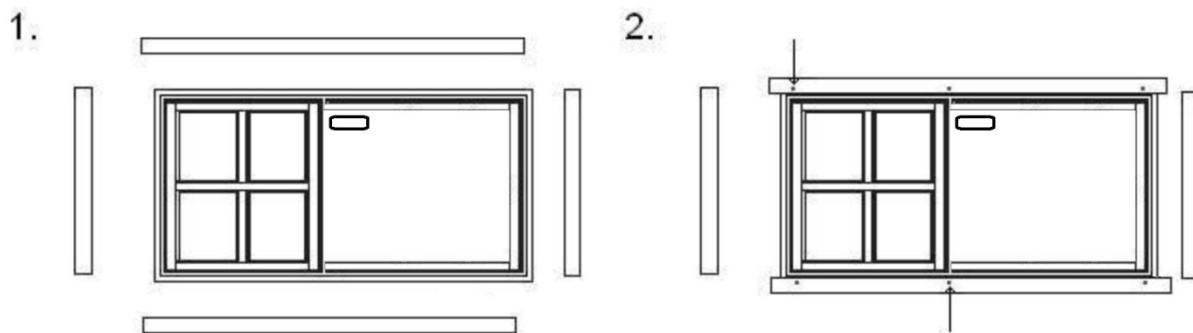

Screw the support trims in to the door frame and insert door frame in to its space from the outside of the structure. Then fix the rest of the support trims from inside the building:

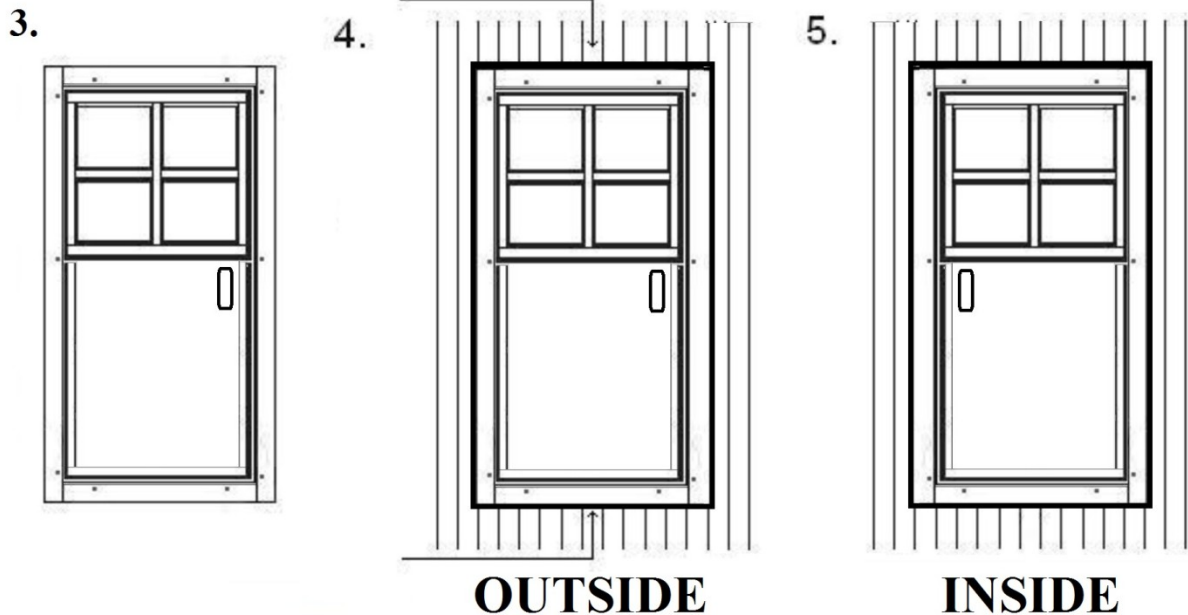

**Notice:**

- **Keep in mind that the support trims must be screwed to the door frames, not to the wall-boards!**
- **Do not worry about the space between the wall and upper window frame. The wood will naturally contract so that the space should disappear within a month or so. Do not try to fill the space in yourself during the assembly process.**

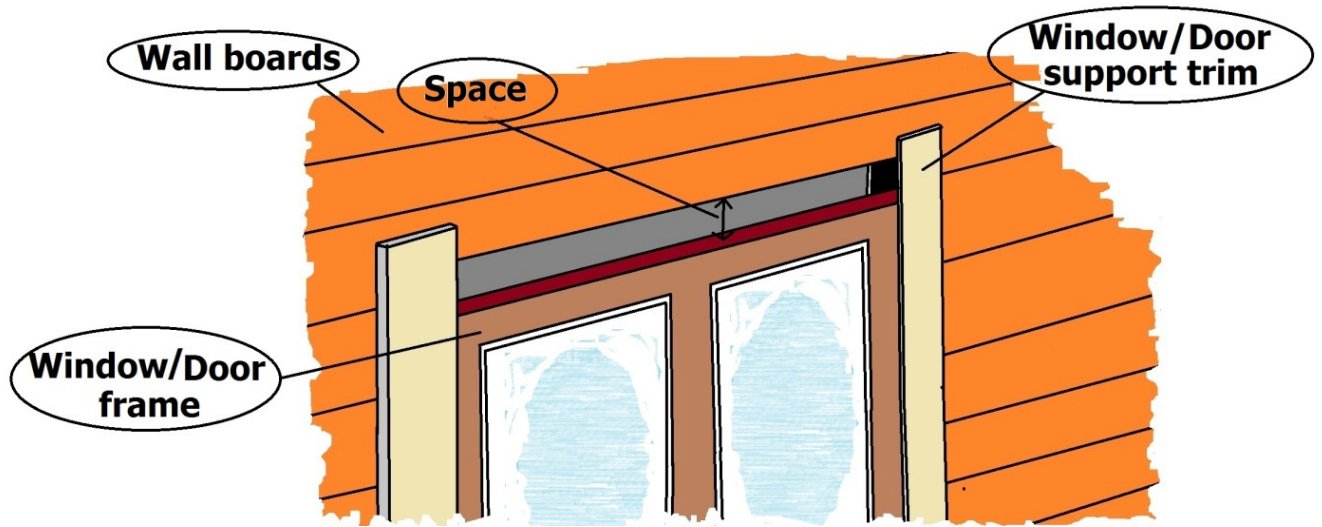

**4.10. Windows:** The windows must be installed in the same way as the door:

1.

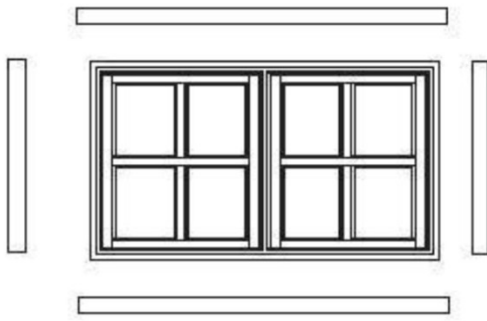

Place the window frame and four support trims on the stable surface.

2.

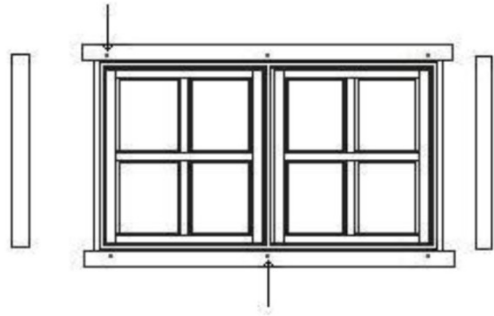

Drill the holes in the support trims and screw them in to the window frame.

3.

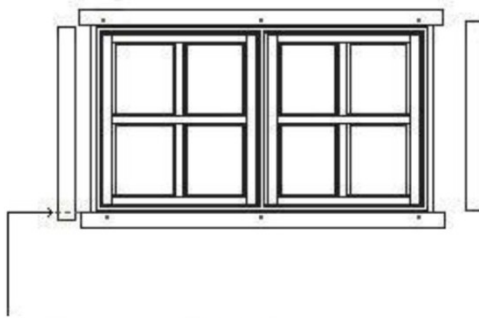

Cut the support trims if necessary

4.

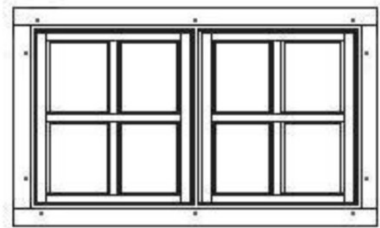

All four support trims are fixed

5.

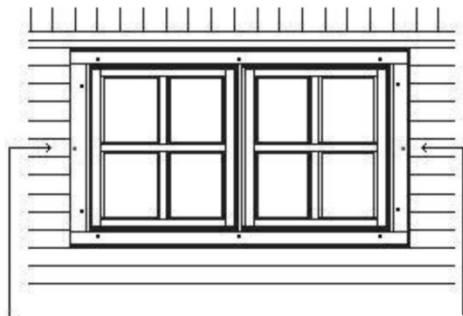

Just insert the window frame in to the space (no screwing)

6.

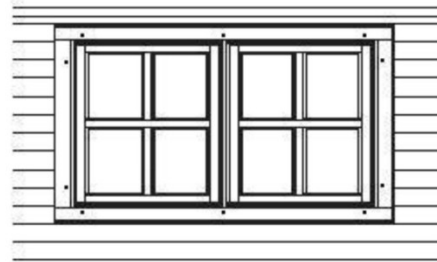

Now screw the rest four support trims in to the window frame from the other side.

**4.11. Floor:** Place the floor-boards across the bearers and screw them in at an angle. In this way you will have a screw-free clear floor. After the floor-boards are mounted, screw the floor-boards decorative trims in to the floor-boards.

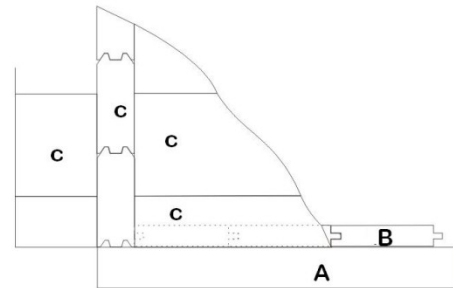
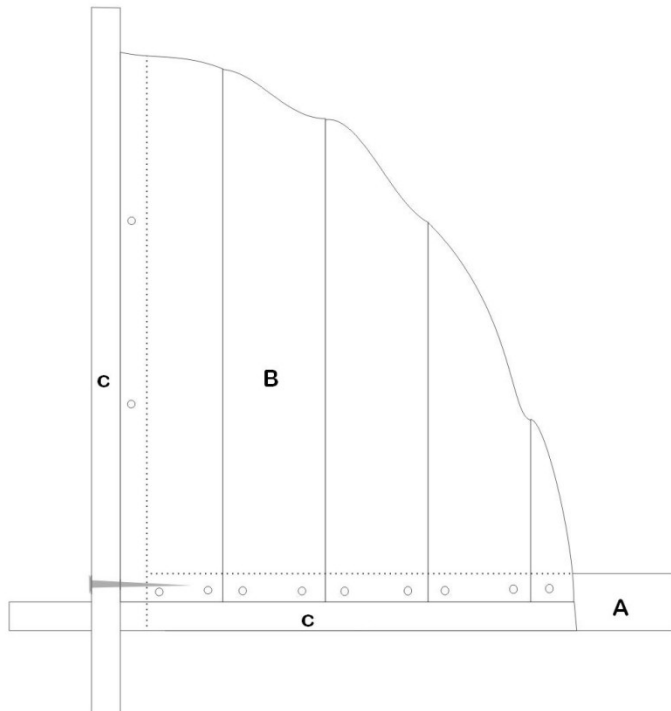

A, - Bearers  
 B, - Floor-boards  
 C, - Wall-boards

**4.12. Felt roof shingles:** When the whole structure is assembled and has been treated, attach the felt roof shingles to the roof-boards as shown in the picture. We recommend that you cover the roof only after the structure has been treated.

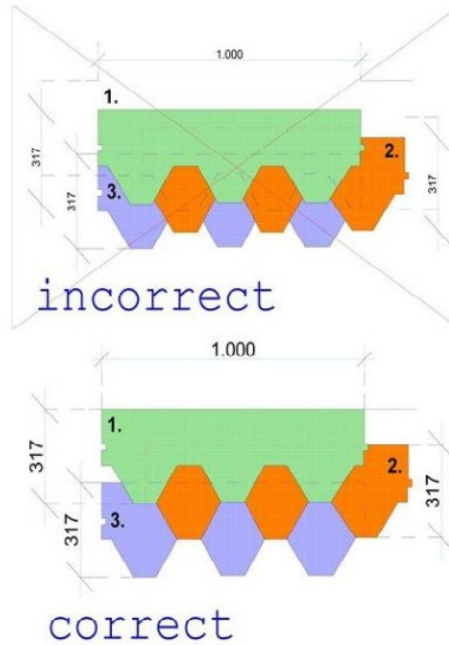

**Treatment.** It is important to treat the product using a quality wood-preservative instantly after the assembly process is finished. Apply at least 2 coats to the outside and 1 to the inside. Repeat annually.

We hope you enjoy your purchase.

**Sincerely yours**  
**DIHC ApS team**